

Trinitron® Color Video Monitor

# PVM-4300

## Operating Instructions page 2

Before operating the unit, please read this manual thoroughly and retain it for future reference.

## Mode d'emploi page 30

Avant la mise en service de cet appareil, prière de lire attentivement ce mode d'emploi que l'on conservera pour toute référence ultérieure.

## Owner's Record

The model and serial numbers are located on the rear.  
Record the serial number in the space provided below.  
*Refer to these numbers whenever you call upon your Sony dealer regarding this product.*

Model No. PVM-4300      Serial No. \_\_\_\_\_

PROPERTY OF THE  
NATIONAL TECHNICAL DEPT.  
FILE COPY  
Do not remove

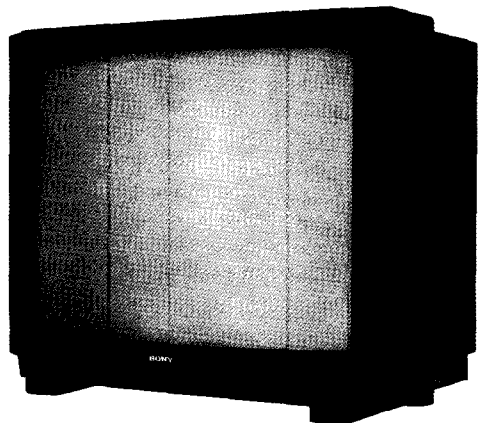

**WARNING**

**To prevent fire or shock hazard, do not expose the unit to rain or moisture.**

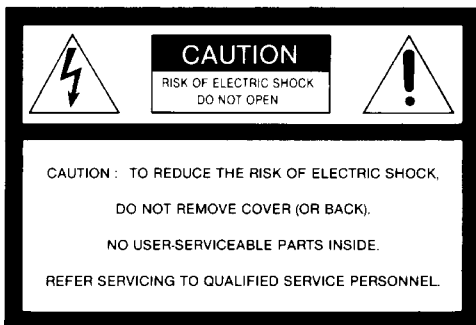

This symbol is intended to alert the user to the presence of uninsulated "dangerous voltage" within the product's enclosure that may be of sufficient magnitude to constitute a risk of electric shock to persons.



This symbol is intended to alert the user to the presence of important operating and maintenance (servicing) instructions in the literature accompanying the appliance.

**For the customers in the USA****INFORMATION**

This equipment generates and uses radio frequency energy and if not installed and used properly, that is, in strict accordance with the manufacturer's instructions, may cause interference to radio and television reception. It has been type tested and found to comply with the limits for a Class B computing device in accordance with the specifications in Subpart J of Part 15 of FCC Rules, which are designed to provide reasonable protection against such interference in a residential installation. However, there is no guarantee that interference will not occur in a particular installation. If this equipment does cause interference to radio or television reception, which can be determined by turning the equipment off and on, the user is encouraged to try to correct the interference by one or more of the following measures:

Reorient the receiving antenna

Relocate the equipment with respect to the receiver

Move the equipment away from the receiver

Plug the equipment into a different outlet so that equipment and receiver are on different branch circuits.

If necessary, the user should consult the dealer or an experienced radio/television technician for additional suggestions. The user may find the following booklet prepared by the Federal Communications Commission helpful:

"How to Identify and Resolve Radio-TV Interference Problems".

This booklet is available from the U.S. Government Printing Office, Washington, DC 20402, Stock No. 004-000-00345-4.

**For the customers in Canada**

This apparatus complies with the Class B limits for radio noise emissions set out in Radio Interference Regulations.

# Contents

Features .....	3
Precautions .....	3
Location and function of parts and controls .....	4
Installation .....	10
System connections .....	11
Viewing the picture from a video equipment .....	17
Watching TV programs .....	17
Monitoring an analog RGB signal .....	18
Adjusting the picture and sound .....	18
Using the programmable remote commander .....	21
Specifications .....	28

# Features

**This color monitor features a 45"black TORINITRON® picture tube for a high resolution,high contrast picture.**

**IDTV(improved definition TV) realized by various digital technologies such as non-interlace and three-dimensional comb filter,etc.**

**In addition, the following analog circuits are employed:**

- **Auto cut-off circuit** keeps the color temperature(tint) of the picture for the most pleasing color.
- **Colorpure Filter™ (CCD)** produces fine picture detail without color spill or color noise.
- **New Dynamic picture™ system** adjusts picture contrast automatically to produce more detail in both bright and dark area of every scene.

**Other convenient features**

- S VIDEO IN jack which is connected to the S video output jack on the VTR allows superior playback pictures.
- RGB connectors to connect a microcomputer for displaying the characters and color graphics.
- The programmable remote commander allows you to operate video equipment made by Sony or other manufacturers.

# Precautions

## Safety

- Operate the unit only on 120 V AC.
- One blade of the plug is wider then the other for purpose of safety and will fit into the power outlet only one way. If you are unable to insert the plug fully into the outlet, contact your dealer.
- Should any liquid or solid object fall into the cabinet, unplug the unit and have it checked by qualified personnel before operating it any further.
- Unplug the unit from the wall outlet if it is not going to be used for several days or more. To disconnect the cord, pull it out by the plug. Never pull the cord itself.

## Installation

- To prevent internal heat build-up, do not block the ventilation openings.
- Do not install the unit in a hot or humid place or in a place subject to excessive dust or mechanical vibration.

## Cleaning

Clean the unit with a slightly damp soft cloth. Use a mild household detergent. Never use strong solvents such as thinner or benzine as they might damage the finish of the cabinet.

## Repacking

Retain the original carton and packing materials for safe transport of this unit in the future.

If you have any questions about this unit, contact your authorized Sony dealer.

# Location and Function of Parts and Controls

## Front

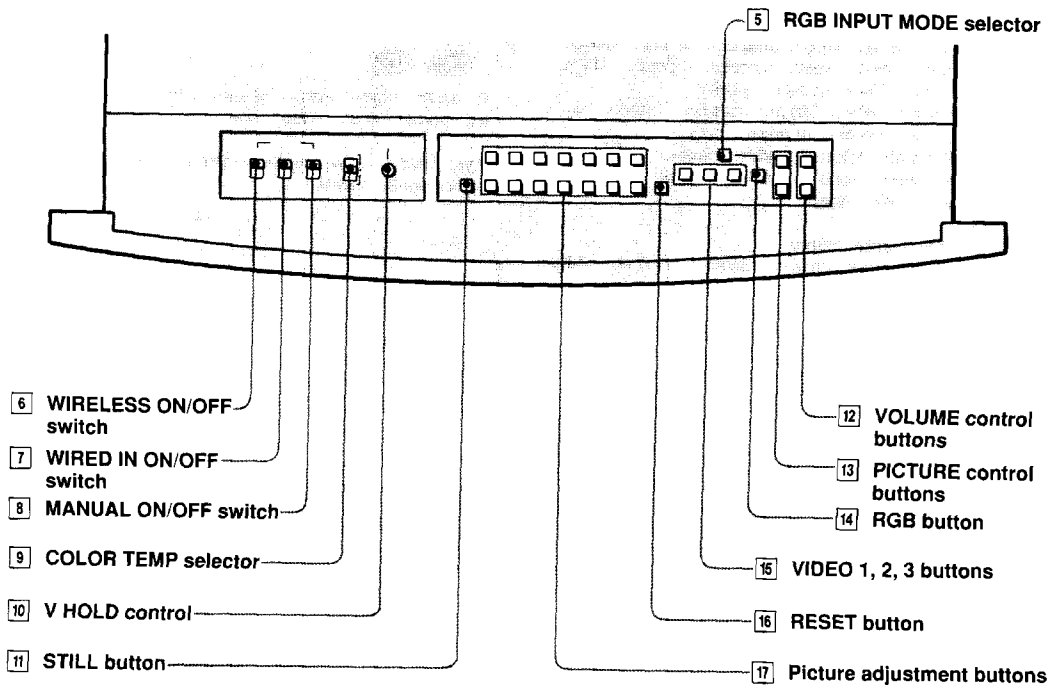
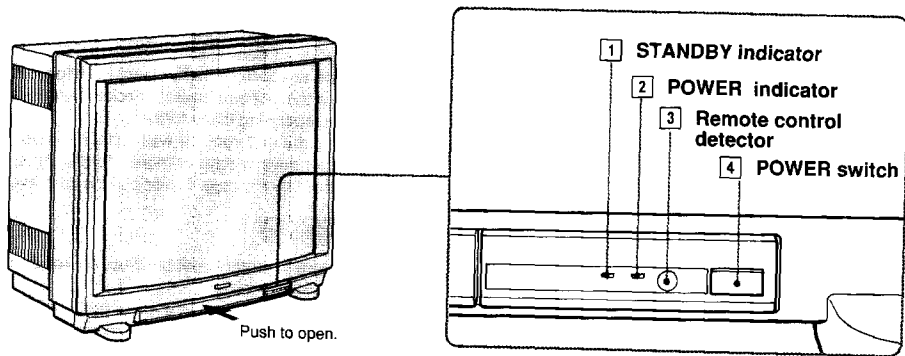



**1** **STANDBY indicator**

Illuminates when the power is turned off by the remote commander and the unit is set in the standby mode.

**2** **POWER indicator**

Illuminates when the power is turned on.

**3** **Remote control detector**

The beam from the remote commander is received here.

**4** **POWER switch**

Press this switch to turn on the monitor.  
Press it again to turn off the monitor.

**5** **RGB INPUT MODE selector**

Set to 31.5 kHz when connecting an equipment with 31.5 kHz horizontal frequency to the RGB (31.5 kHz) input connector. Otherwise, set to 15.75 kHz.

**6** **WIRELESS ON/OFF switch**

Normally set to ON. Set to OFF so that the remote control detector does not accept the beam from the remote commander.

**7** **WIRED IN ON/OFF switch**

Normally set to ON, and the control S signal can be input to the monitor. Set to OFF not to input the control S signal to the monitor.

**8** **MANUAL ON/OFF switch**

Normally set to ON. Set to OFF so that the all controls and buttons on the front panel cannot be operated.

**9** **COLOR TEMP (temperature) selector**

Use this selector to adjust the color temperature.

**10** **V HOLD (vertical hold) control**

When the picture rolls vertically, correct it with this control.

**11** **STILL button**

Press this button to view the still picture. Press this button again to restore the normal picture.

**12** **VOLUME control buttons**

Press + to raise the volume or - to lower it.

**13** **PICTURE control buttons**

Press + to increase the contrast or - to decrease it.

**14** **RGB button**

Press this button to monitor the signal fed through the RGB input connectors to the monitor.

**15** **VIDEO 1, 2, 3 buttons**

Press each button to select the VTR connected to the respective VIDEO 1, 2, 3 connector.

**16** **RESET button**

Press this button to reset picture and sound adjustments to the factory preset level.

**17** **Picture adjustment buttons**

**BALANCE control buttons**

Press L to increase the sound volume of the left speaker or R to increase the sound volume of the right speaker.

**BASS control buttons**

Press + to increase the bass (low tone) or - to decrease it.

**TREBLE control buttons**

Press + to increase the treble (high tone) or - to decrease it.

**SHARP (sharpness) control buttons\***

Press + to obtain a sharp picture or - to obtain a less sharp picture.

**BRIGHT (brightness) control buttons**

Press + to make the picture brighter or - to make it darker.

**COLOR control buttons\***

Press + to make the color intensity vivid or - to make it darker.

**HUE control buttons\***

Press G (green) to make the skin tones greenish or R (red) to make it purplish.

\* These buttons have no effect on the picture fed through the RGB (31.5 kHz) connectors.

# Location and Function of Parts and Controls

## Rear

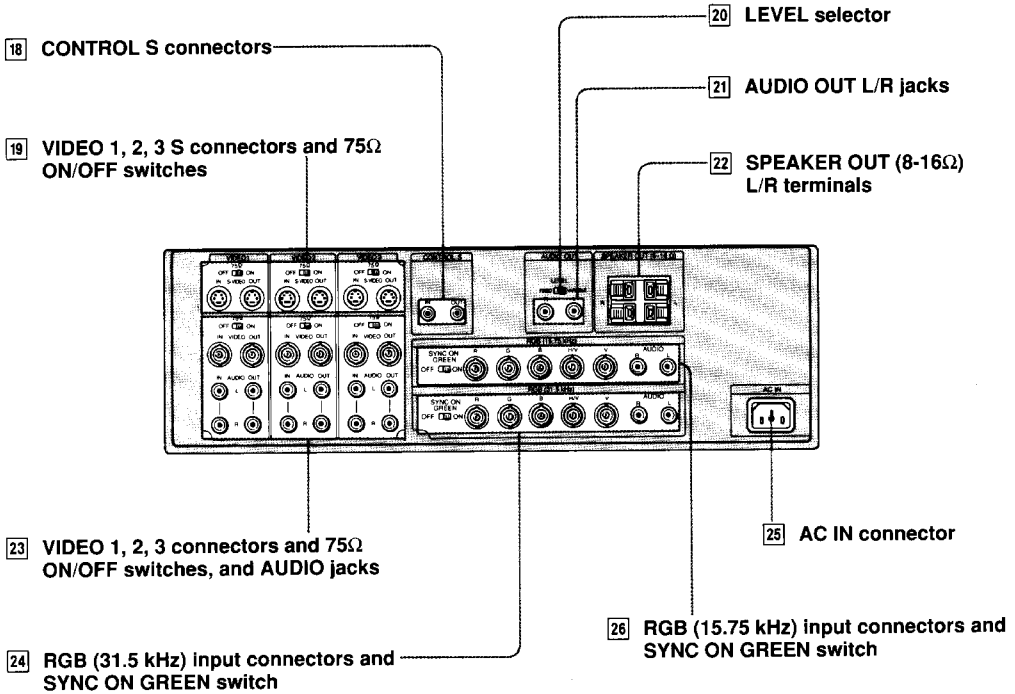

**18 CONTROL S IN/OUT connectors** (mini-jack)  
Connect to the CONTROL S connectors of a VTR or several monitors.  
It is then possible to control the system with a single remote commander.

**19 VIDEO 1S, VIDEO 2S, VIDEO 3S connectors** (4-pin DIN)  
**IN:** Connect to the VTR with an S VIDEO output connector.  
**OUT:** Connect to the S VIDEO input connector of another monitor.  
**75Ω (termination) ON/OFF switches**  
Normally set to ON.  
When the OUT connector is connected to another monitor to view the same picture on several monitors (loop-through connection), set the switch to OFF.

**20 LEVEL selector**  
Set to VARIABLE to change the volume and tone quality with the buttons on the monitor or the remote commander.  
Set to FIXED to keep the volume and tone quality at a certain level.

**21 AUDIO OUT L/R jacks** (phono jack)  
When listening to the sound through an audio equipment, connect to the audio inputs of an amplifier.

**22 SPEAKER OUT (8-16Ω) L/R terminals**  
Connect to speakers with 8 to 16 ohms impedance.

**23 VIDEO 1, VIDEO 2, VIDEO 3 connectors** (BNC type)  
**IN:** Connect to the VTR with video output connector.  
**OUT:** Connect to the video input connector of another monitor.  
**AUDIO IN/OUT connectors** (phono jack)  
Connect to the audio input/output connectors of a VTR or a monitor.  
**75Ω (termination) ON/OFF switches**  
Same as that of **19**.

**24 RGB (31.5 kHz) input connectors** (BNC type)  
Connect to an equipment with 31.5 kHz horizontal frequency.  
**SYNC ON GREEN switch**  
Set to ON to synchronize with the sync signal on G-signal.  
Set to OFF to synchronize with H/V sync signal or composite sync signal.

**25 AC IN connector**  
Connect to an outlet using the supplied AC power cord.

**26 RGB (15.75 kHz) input connectors** (BNC type)  
Connect to a microcomputer, etc. with analog RGB output.  
**SYNC ON GREEN switch**  
Same as that of **24**.

## Programmable Commander RM-778

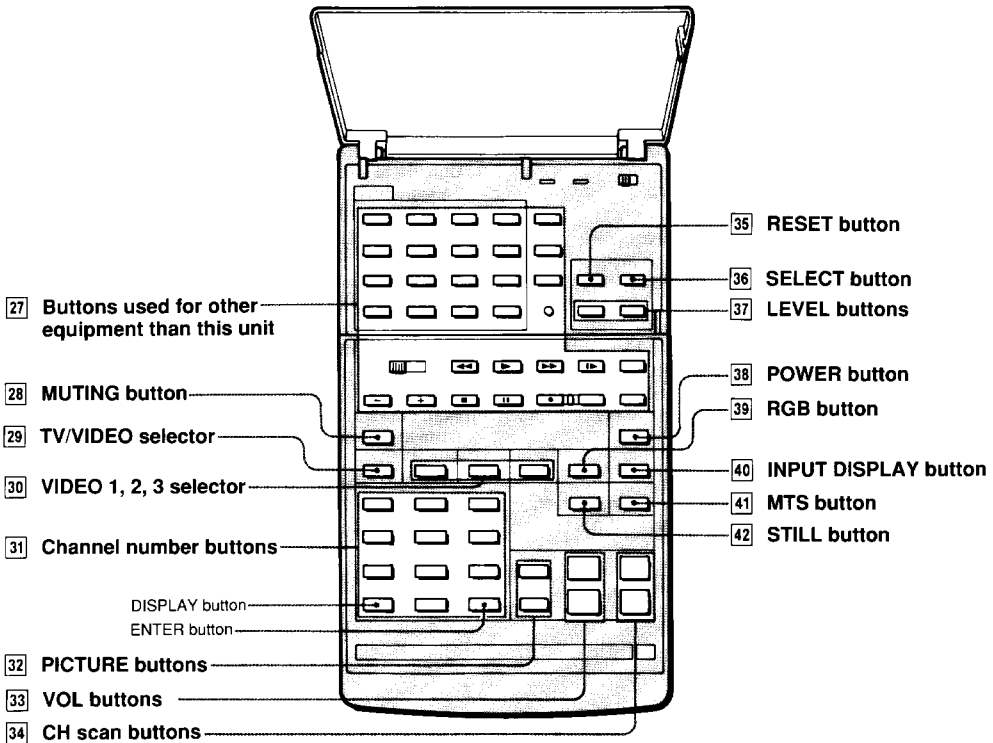

### Battery installation

Insert the supplied four size "AA" batteries (IEC designation R6) with the correct polarity.

1

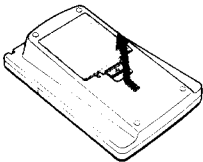

2

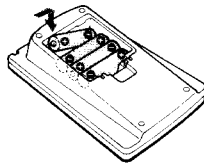

#### Notes

- In normal operation, batteries will last up to half a year. If the unit does not operate properly, the batteries might be exhausted. Replace all with new ones.
- To avoid damage from possible battery leakage, remove the batteries for extended unused periods.
- Be sure that there are no obstructions between the commander and the TV.
- Operable range is limited.

The shorter the distance between the commander and the unit, the wider the angle within which the commander can control the unit.



**27) Buttons used for other equipment than this unit**

See "Using the programmable remote commander" (page 21) for operation of these buttons.

**28) MUTING button**

Press this button to mute the sound.  
Press this button again to restore the sound.

**29) TV/VIDEO selector**

Used for Sony TV or color TV tuner.  
Press to change from the TV picture to the video picture, or from the video picture to the TV picture.

**30) VIDEO 1, 2, 3 selector**

Press each button to select the equipment connected to the respective VIDEO 1, 2, 3 connector.

**31) Channel number buttons**

Used for Sony TV or color TV tuner.  
Press number buttons and ENTER when selecting channel directly.  
Press DISPLAY to turn on or off the channel display.

**32) PICTURE buttons**

Press + to increase the picture contrast, or - to decrease it.

**33) VOL (volume) buttons**

Press + to raise the volume, or - to lower it.

**34) CH (channel) scan buttons**

Press + to scan preset channels of higher numbers, or - to scan preset channels of lower numbers.

**35) RESET button**

Press this button to reset the picture and sound adjustments to the factory preset level.

**36) SELECT button**

Used for selecting the item to be adjusted.

**37) LEVEL buttons**

Press +(R) or -(L) to adjust the item or sound selected with the SELECT button.

**38) POWER button**

Press this button to turn on the monitor.  
Press it again to turn off the monitor.

**39) RGB button**

Press this button to monitor the signal fed through the RGB input connectors.

**40) INPUT DISPLAY button**

Press to indicate the input source on the screen, such as VIDEO 1, 2, 3, or RGB.

**41) MTS (Multichannel TV Sound) button**

Press this button to select MAIN, SAP (Second Audio Program), or MONO of the Multichannel TV Sound program.

**42) STILL button**

Press this button to view the still picture.  
Press it again to restore the normal picture.

# Installation

## Precautions on Installation

- Connect the AC IN connector on the rear of the unit to an outlet with the supplied AC power cord.
- After installation, or when the monitor has been moved, or when its direction has been changed, beam landing adjustment is required. Please consult your Sony representative.
- This unit weighs approximately 200 kg (440 lb 15 oz). Make sure that the floor is strong enough.
- In order to prevent accidents resulting from unstable installation, or in emergencies such as earthquakes, please consult your Sony representative.
- Do not place a magnetized object, such as speakers, steel frames, etc., near the unit. Doing so may cause uneven color.
- Leave sufficient open space behind the unit for connecting a VTR, etc.

## How to Secure

- 3** Securely tie the bracket in a strong position, such as to a pillar, with a thick steel wire.

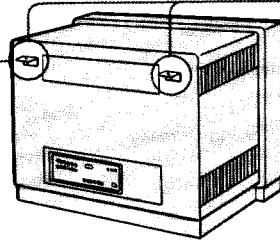
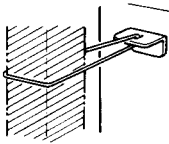

- 1** Remove the screws.

- 2** Attach the brackets with the screws.



# System Connections



## Connection Example

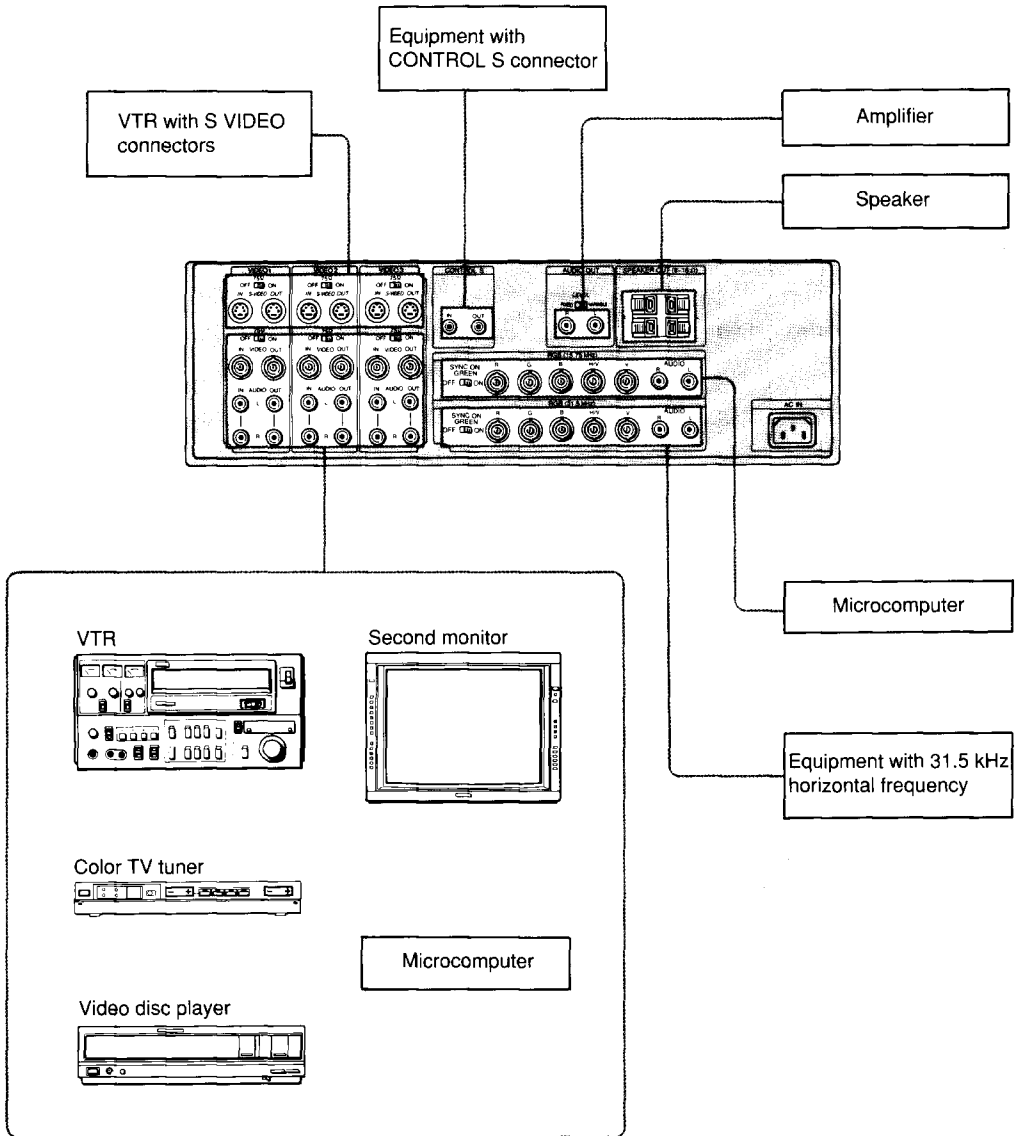

## Connection Quick Reference

	Operation	Connecting equipment	Connectors on the monitor	Page
Video connection	Watching TV	Color TV tuner VTR with tuner	VIDEO IN	13
	Watching TV	VTR or tuner timer unit and deck	VIDEO IN	13
	Recording the picture on the screen			
	Playing back the video tape			
	Playing back the video disc	Video disc player	VIDEO IN	13
	Displaying characters and color graphics	Microcomputer	VIDEO IN	13
RGB connection	Displaying characters and color graphics	Microcomputer	RGB IN (15.75 kHz)	14
		Equipment with 31.5 kHz horizontal frequency	RGB IN (31.5 kHz)	14
Audio connection	Listening to or recording the stereo sound from a TV or a VTR	Stereo amplifier of an audio system	AUDIO OUT	14

### Notes on connection

- Turn off the power to all equipment before making any connection.
- Make firm connections. A loose connection may cause hum or noise.
- When disconnecting a cord, pull it out grasping the plug. Never pull the cord itself.
- To prevent interference, turn off all connected equipment which is not currently in use.
- If there is noise in the picture or sound, try moving the equipment further apart.

### Notes on connecting the optional speakers

- Use speakers which have a rated impedance of 8 to 16 ohms.
- When speakers without magnetic shielding are placed next to the monitor, they may cause uneven color. In this case, place the speakers apart from the monitor. If uneven color is still observed, turn off the power. Wait for more than 15 minutes before turning on the power again.

- Securely insert the speaker cords in the speaker terminals in order to prevent short-circuit of the speaker terminals.
- Make correct connections of L, R, ⊕, and ⊖ of the speaker cords and terminals.
- Do not connect one set of speakers to both the amplifier and the monitor. An excessive current may flow from the amplifier to the monitor through the speaker cord. This may damage the monitor.

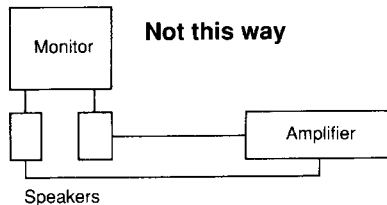

- For further details, refer to the operating instructions of the speakers.

## Connecting VTRs with an S Video Output Jack

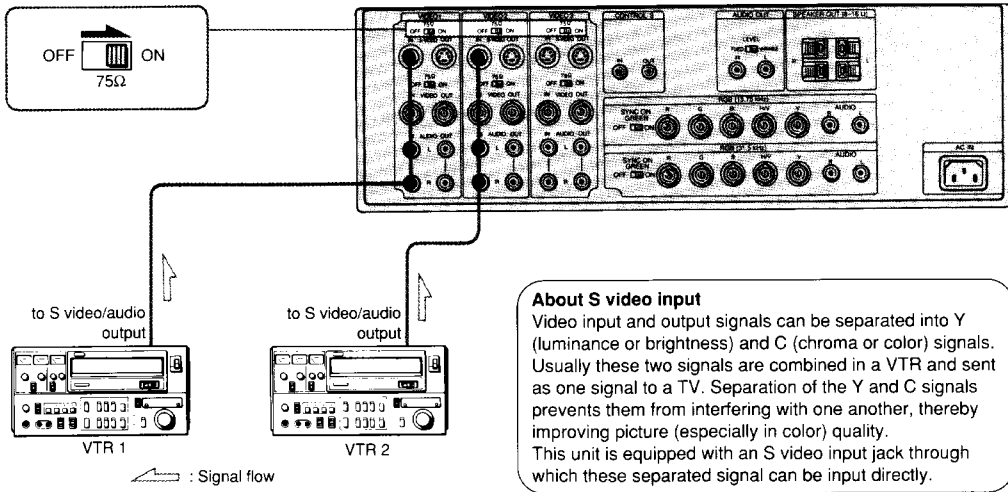

## Connecting VTRs/Video Disc Players Not Equipped with an S Video Output Jack

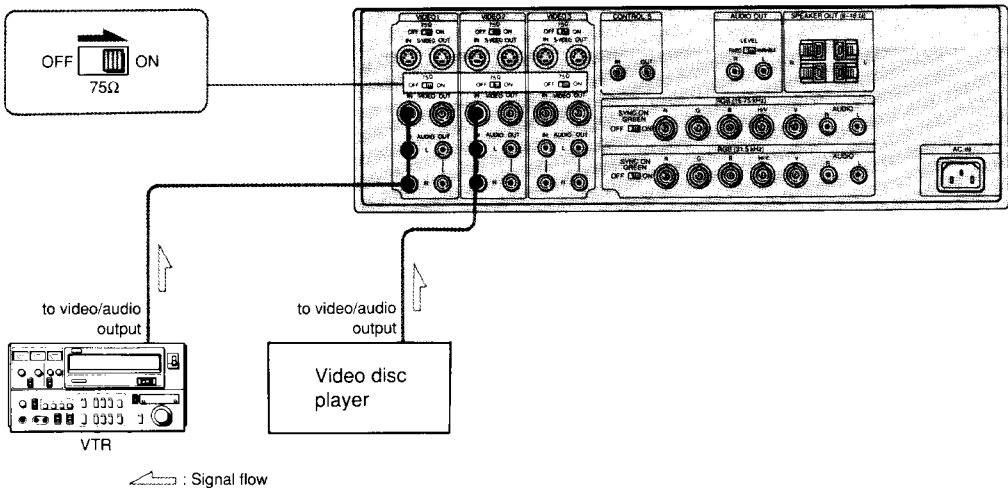

## Connecting a Microcomputer

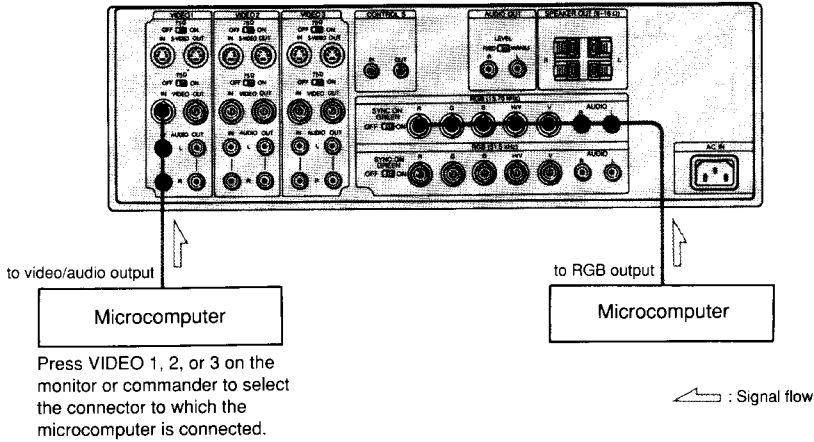

### Notes on the connecting a microcomputer

- If a microcomputer with the horizontal sync frequency largely out of standard is connected, the picture may be unclear.
- When the microcomputer has a non-interlace mode selector, set it to the ON position.
- Some pictures may be unclear depending on the type of picture or the type of microcomputer connected to the RGB input connectors. This is not a malfunction of the monitor.

## Connecting an Audio System

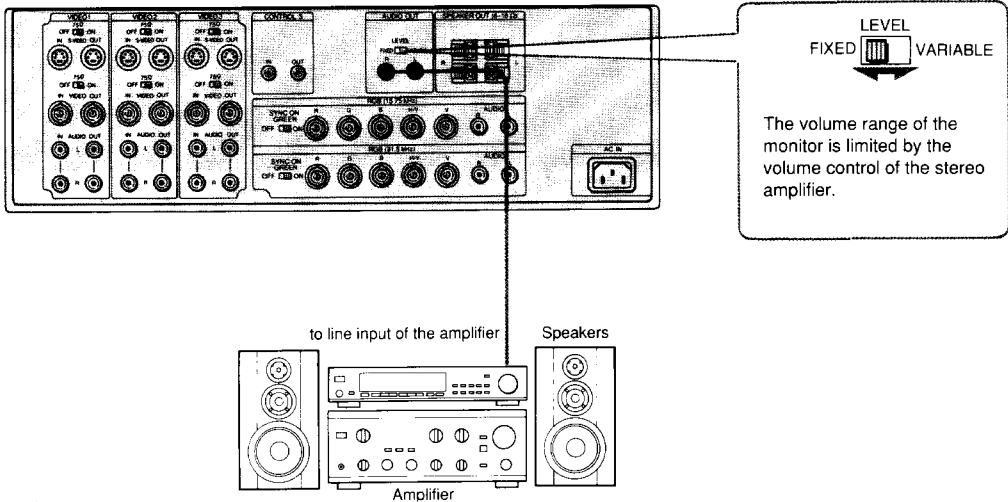

## CONTROL S Connection

The following connections allow remote control of several monitors and a VTR through a single monitor.

### Example 1 When operating through the remote control detector of the monitor

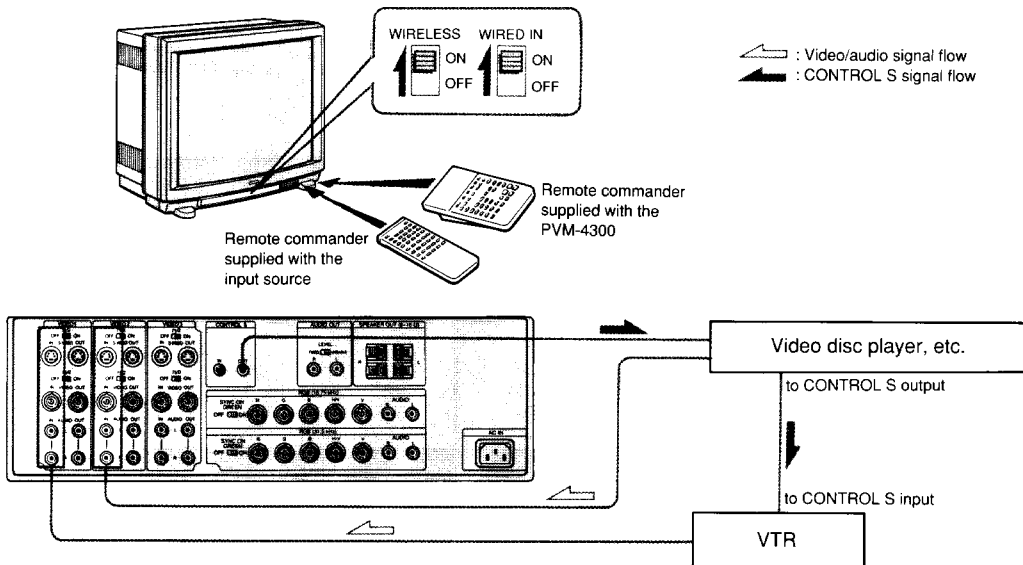

### Example 2 When operating through the remote control detector of the VTR, etc.

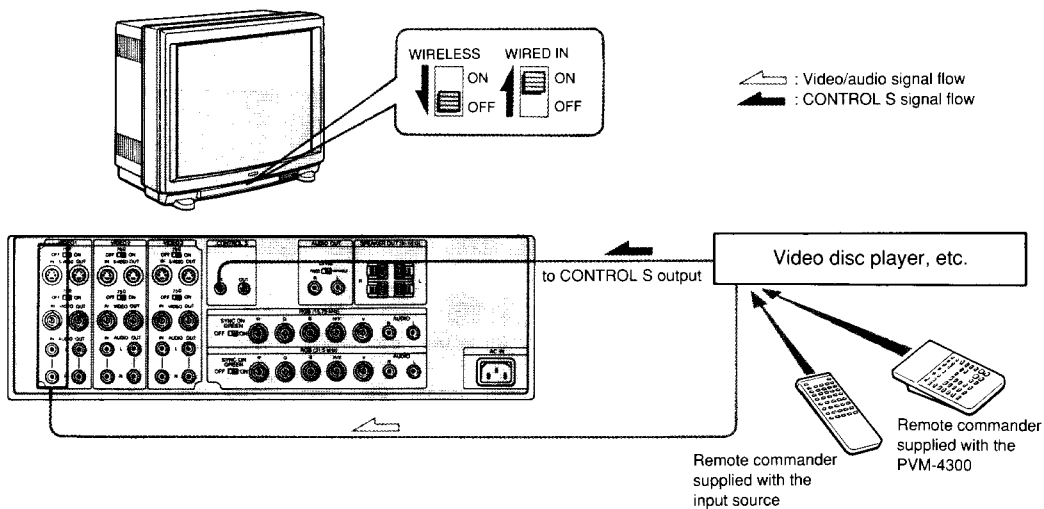

## Connecting Several Monitors – Loop-through Connection

A loop-through connection is convenient for monitoring the same signal on other monitors. Up to five monitors can be connected.

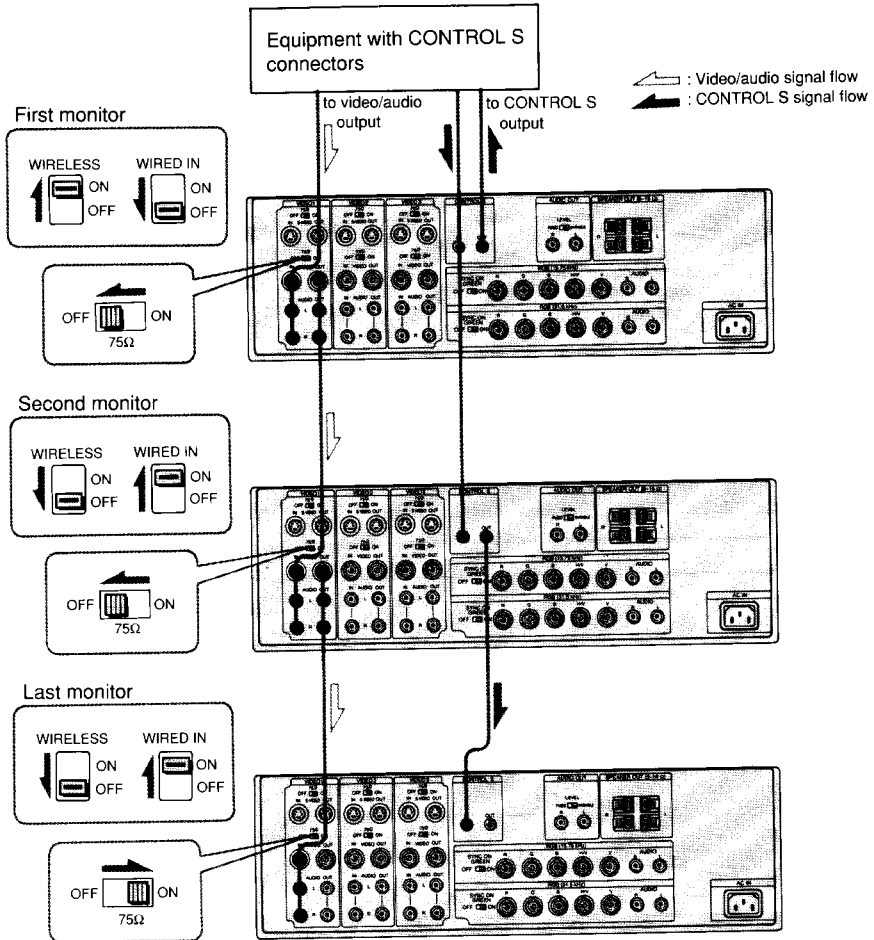

**Note**

Do not use the following loop connection.

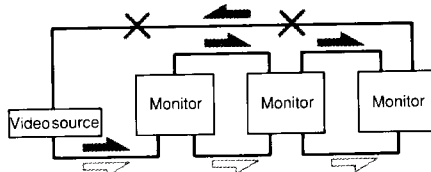



# Viewing the Picture from a Video Equipment

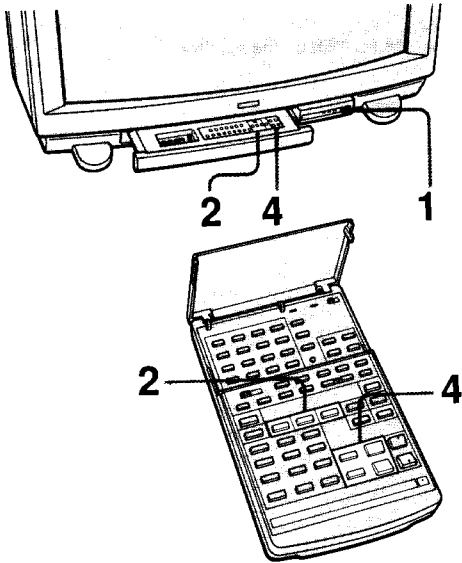

- 1** Depress **POWER** on the monitor.
- 2** Select the input signal by pressing **VIDEO 1, 2, or 3**.
- 3** Set the video equipment in the **playback mode**.  
The video equipment connected to the monitor can be controlled with the supplied remote commander. For the operation, see page 22.
- 4** Adjust the **volume and picture**.  
For details on the adjustment, see page 19.

# Watching TV Programs

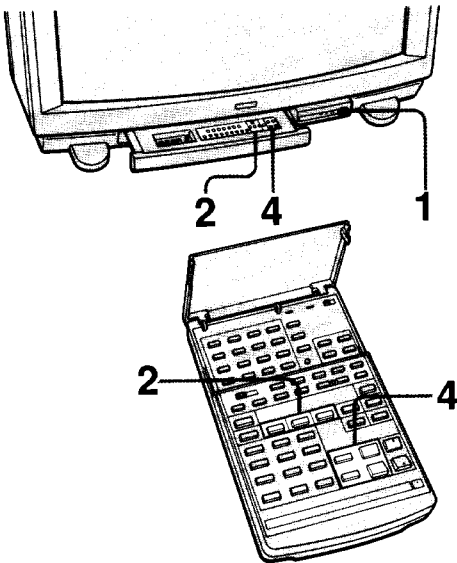

- 1** Depress **POWER** on the monitor.
- 2** Select the input signal by pressing **VIDEO 1, 2, or 3**.
- 3** Turn on the **color TV tuner**, and select the desired **channel**.  
The color TV tuner connected to the monitor can be controlled with the supplied remote commander. For the operation, see page 23.
- 4** Adjust the **volume and picture** (page 19).

# Monitoring an Analog RGB Signal

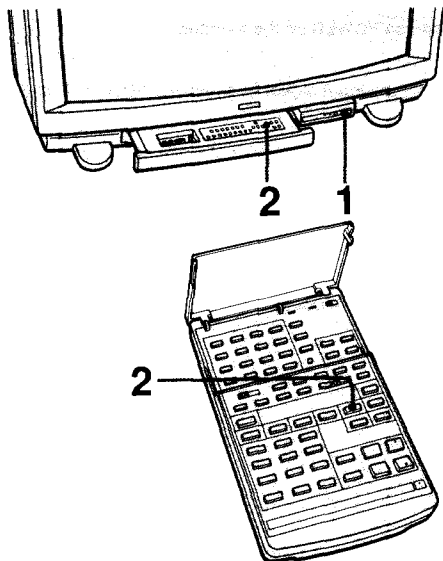

- 1 Depress POWER on the monitor.
- 2 Press RGB.
- 3 Operate the connected equipment to output the signal.

## Adjusting the Picture and Sound

The picture and sound level can be adjusted for each input mode of VIDEO 1, 2, 3 and stored until the next adjustment.

### Adjusting with the Supplied Remote Commander

- 1 Press SELECT to display the item to be adjusted.

Each time SELECT is pressed, the adjusting item changes in the following sequence.

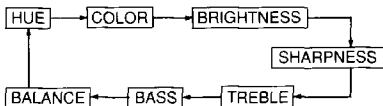

- 2 Press LEVEL +(R) or -(L) to adjust the level.

### Adjusting with the Buttons on the Monitor

Use each adjustment button. (See "Location and function of parts and controls".)









#### Note

The color may be unstable for a few seconds after the power is turned on. This is caused by the auto cut-off circuit function, and is not a malfunction of the monitor.

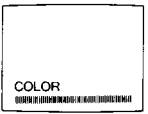
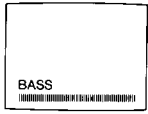

## On-screen Display

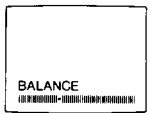
When a picture and sound adjustment button is pressed, or an adjusting item is selected, one of the following on-screen displays appears.

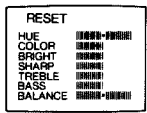
Item	On-screen display	Item	On-screen display
<b>Picture contrast</b>	Press [ ] .  Press [ + ] . Less contrast ← → More contrast	<b>Volume</b>	Press [ ] .  Press [ + ] . Less volume ← → More volume
<b>Hue</b>	Press [ R ] .  Press [ G ] . Skin tones become purplish ← → Skin tones become greenish.	<b>Treble</b>	Press [ ] .  Press [ + ] . Less treble ← → More treble
<b>Color intensity</b>	Press [ ] .  Press [ + ] . Color intensity decreases. ← → Color intensity increases.	<b>Bass</b>	Press [ ] .  Press [ + ] . Less bass ← → More bass
<b>Brightness</b>	Press [ ] .  Press [ + ] . Darker ← → Brighter	<b>Balance</b>	Press [ L ] .  Press [ R ] . Left speaker sound increases. ← → Right speaker sound increases.
<b>Sharpness</b>	Press [ ] .  Press [ + ] . Softer ← → Sharper	<b>Reset</b>	Press RESET.  Factory preset level

### Enjoying Convenient Features

#### Muting the sound

Press MUTING. The "MUTING" indication will appear on the screen. To restore the sound, press MUTING again or VOL +.

#### Viewing the still picture

Press STILL.

#### Note

- While viewing the still picture, do not press the VIDEO button nor turn off the power.
- Although the picture stops, the sound keeps on going.

#### To make the buttons on the front panel inoperable

Set MANUAL ON/OFF to OFF, so that the sound and picture quality, and sound volume can be kept at a certain level.

#### To reset picture and sound adjustments to the factory preset level

Press RESET.

# Using the Programmable Remote Commander

— Operating Other Equipment with Supplied Remote Commander

The supplied RM-778 remote commander allows you to operate other Sony video equipment having an infrared remote control detector. Furthermore, it can "read" and "store" the functions of another remote commander having an infrared beam transmitter, not only those made by Sony but also those of other manufacturers as well. Thanks to this "learning" function, you can operate your audio and video equipment only with one remote commander.

## Parts Used for Learning Function

### Programmable area

Within this area, any button except the one which is located on the right side of the ● button can "read" and "store" the function of another remote commander.

When storing a function on the ● button, press it by itself. To use it, press it together with the button on the right.

### READY/LEARN lamp

READY lamp: lights up when the LEARN-USE selector is set to LEARN.

LEARN lamp: lights up when learning is finished.

### LEARN-USE selector

Normally, set to USE.

When having the commander store the functions, set to LEARN.

### VTR 1/2/3/MDP selector

By setting this selector, you can choose to operate up to 4 different units.

This button alone cannot store the function of another remote commander. However, to use the ● button after a new function has been stored on it, you must also press this button.

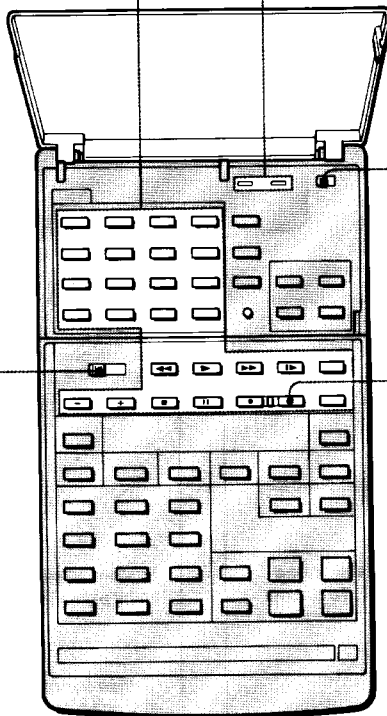

## Operating Sony Video Equipment

The supplied remote commander allows you to operate Sony video cassette recorders (including Beta, 8 mm, VHS), and video disc player (including multi disc player). For operating video equipment manufactured by Sony, "learning" is unnecessary.

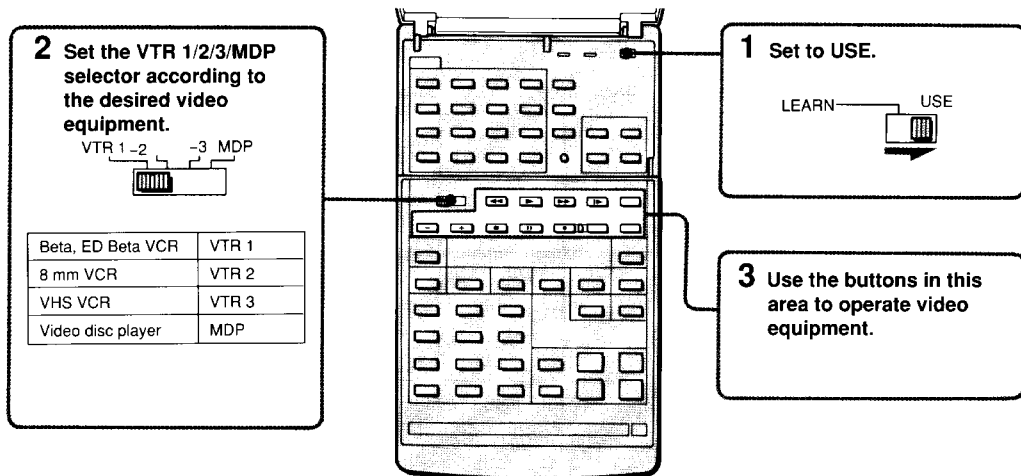

### Operating a Video Cassette Recorder

- |  |  |
|--|--|
| To start recording   | Press ●.   |
| To start playback  | Press ►.   |
| To stop playback   | Press ■.   |
| To advance the tape rapidly                                    | Press ►►.  |
| To rewind the tape   | Press ◄◄.  |
| To freeze a picture  | Press ■■.  |
|  | To resume normal playback, press again.  |
| To view the picture at a fast speed to find a particular scene | Keep pressing ►► or ◄◄ during playback. To resume normal playback, release the button. |
| To view freeze pictures successively at specific intervals     | Press ■■► during playback.   |

### Operating a Video Disc Player

- |  |   |
|--|---|
| To start playback  | Press ►.  |
| To stop playback   | Press ■.  |
| To freeze a picture  | Press ■■.   |
|  | To resume normal playback, press again.   |
|  | * This function is effective only for CAV (standard-play disc). With CLV (extended-play disc), the unit will go into the standby mode if ■■ is pressed. |
| To view the picture at a fast speed to find a particular scene | Keep pressing ►► or ◄◄ during playback. To resume normal playback, release the button.  |
| To view freeze pictures successively at specific intervals     | Press ■■► during playback.  |

### Notes

- If your video equipment is furnished with VTR selector, set the selector to the same position with the VTR 1/2/3/MDP selector on RM-778.
- If the equipment does not have a certain function, the corresponding button on the remote commander is not effective.



## Operating Sony TV or Color TV Tuner

The supplied remote commander allows you to operate Sony TV or color TV tuner. For operating TV or color TV tuner manufactured by Sony, "learning" is unnecessary.

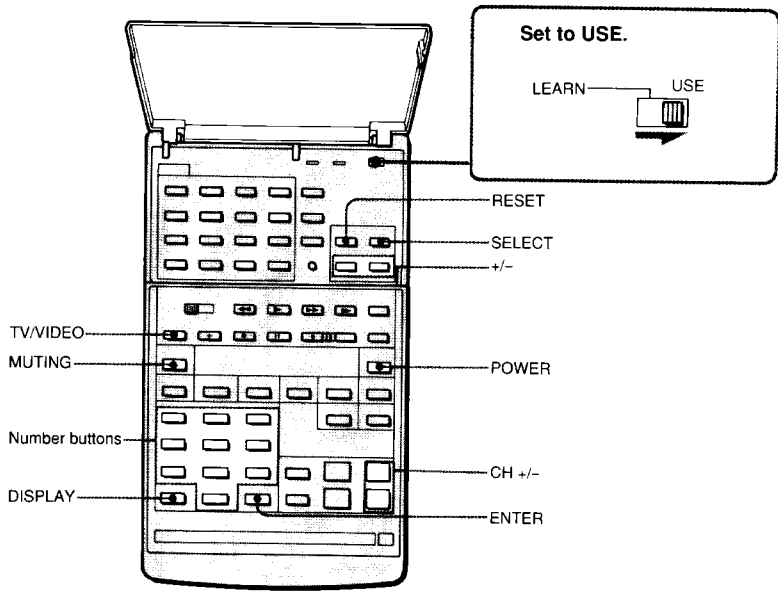

**Operating a TV**

To turn on the TV	Press POWER.
To select the channel	Press the number buttons and then ENTER. Or, press CH +/- buttons.
To mute the sound	Press MUTING.
To change to the video picture	Press TV/VIDEO.
To adjust the TV picture	Press SELECT to select the adjusting item, and adjust with +/- buttons (page 19).
To restore the factory preset level	Press RESET.
To display the channel number	Press DISPLAY.

## Using the Programmable Remote Commander

### Operating Audio and Video Equipment of Other Manufacturers, or Sony Audio Equipment

Within the programmable area, any button can memorize the function of the remote commander supplied with other manufacturer's equipment or Sony audio equipment.

A button can memorize a function having no relation to its name on the commander.

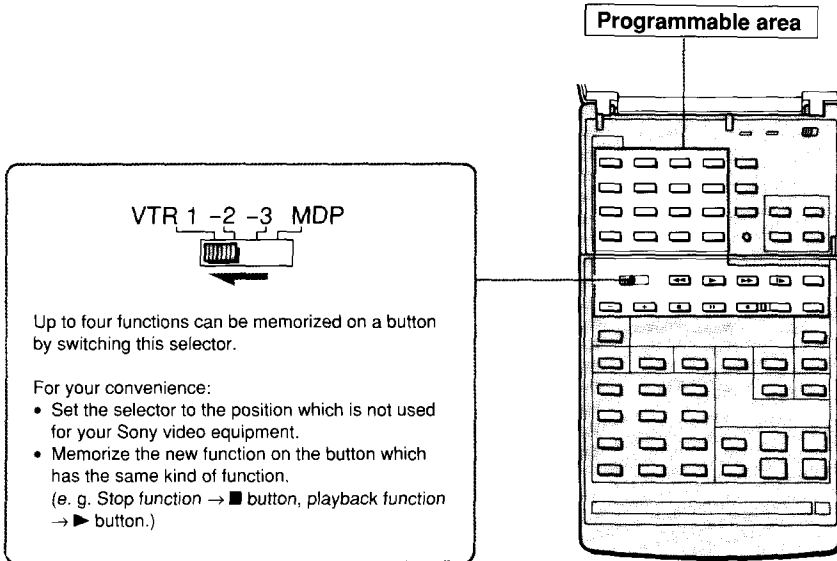

#### Caution

When new function is memorized on the button, the original function to operate Sony video equipment is cleared. After you clear the memorized function (see page 27), the button functions for Sony equipment again.



## How to Use the Learning Function

Example: Operating the video cassette recorder of manufacturer A, when the selector is set to VTR 1.

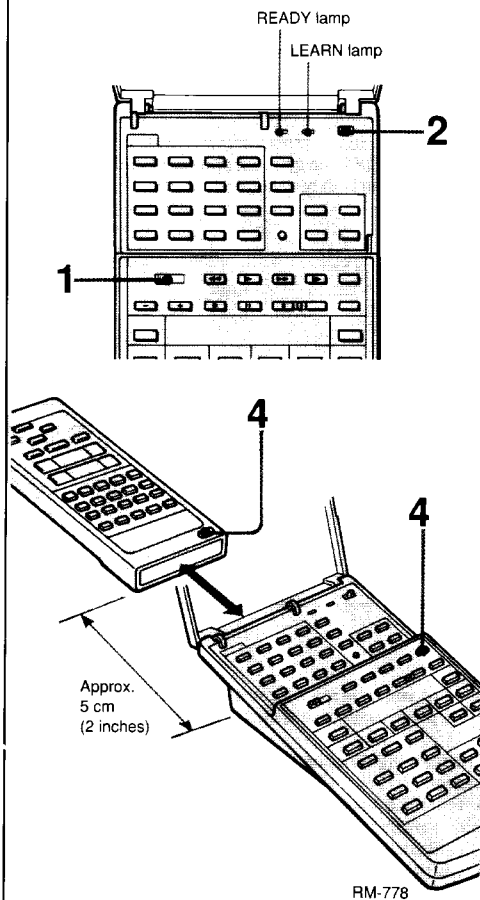

1 Set the VTR 1/2/3/MDP selector to VTR 1.

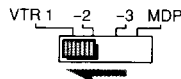

2 Set the LEARN-USE selector to LEARN.

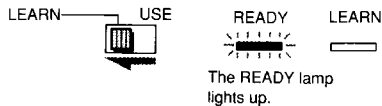

3 Position the RM-778 and the other commander head to head.

Choose a button of the RM-778 to which a function is to be memorized. As an example, let's have the RM-778 learn the power on/off function of manufacturer A's commander.

4 While keeping the POWER button pressed, press the POWER button of the manufacturer A's commander.

5 When the READY lamp goes out and the LEARN lamp lights up, release both buttons.

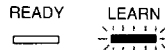

Now, A's power on/off function has been memorized on the POWER button of the RM-778. Repeat steps 4 and 5 to continue learning other functions.

Continued on next page

### For accurate learning

- Be sure that these commanders are positioned head to head exactly aligned, and approx. 5 cm (2 inches) apart.
- Do not move the commanders during the learning process.

### Note

Both READY and LEARN lamps light up if the function has not been memorized. Try again from step 3.

## Using the Programmable Remote Commander

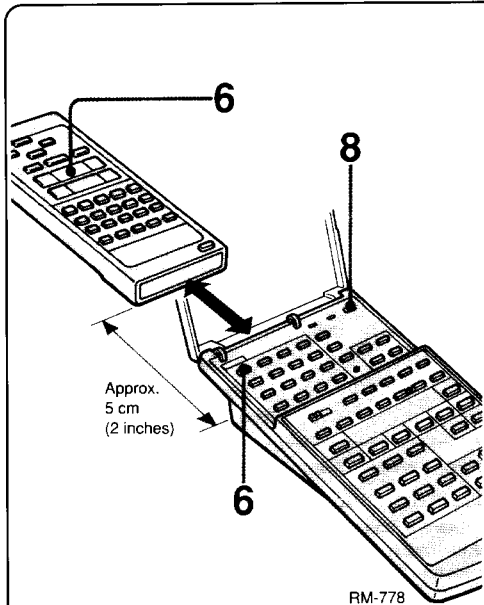

Next, let's have Button 1 on this commander memorize the "play" function of manufacturer A's commander.

**6** While keeping Button 1 on this commander pressed, press the play button of the manufacturer A's commander.

**7** When the READY lamp goes out and the LEARN lamp lights up, release both buttons.

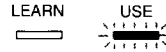

Now, A's play function button has been memorized on Button 1 of the RM-778.

**8** After learning is finished, set the LEARN-USE selector to USE.

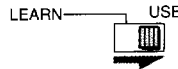

### Notes

- When operating equipment with learned functions, the VTR 1/2/3/MDP selector should be set to the same position as it was when the functions were memorized. The LEARN-USE selector should be set to USE.
- The functions of other equipment can be memorized by repeating these steps for each of the positions of the VTR 1/2/3/MDP selector. Use the supplied index sheets by placing them on buttons and writing the names of memorized functions for further reference.
- The batteries will last about half a year with normal operation. Replace the batteries before they wear out.
- Replace the batteries within approximately 30 minutes. If not, the memorized function on the buttons may be erased.
- Do not use the learning function for equipment other than audio and video ones.
- Be sure to confirm that the functions have been memorized as a few of the functions of other manufacturer's commanders are not storable on RM-778.

- When you have memorized a new function on a button, the previous function is cleared automatically.

### The learning function will not work in the following cases:

- There is a fluorescent lamp or equipment with infrared rays which emit noise.  
→ Move the commanders away from them.
- The batteries are exhausted.  
→ Replace all the batteries with new ones.
- There is an obstacle between the commanders, or the commanders are not positioned head to head and exactly aligned.  
→ Position the commanders properly.

## Clearing Memorized Functions – Clearing Memorized Functions under Each Position on VTR 1/2/3/MDP Selector

Example: Clearing functions memorized on VTR 1 position

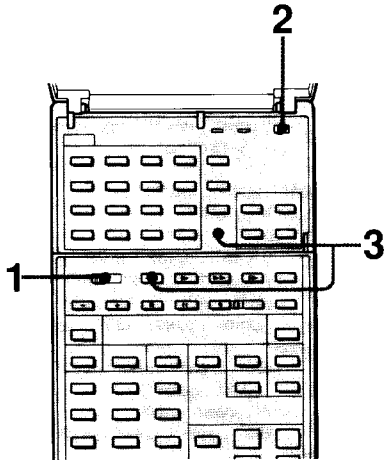

1 Set the VTR 1/2/3/MDP selector to VTR 1.

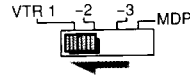

2 Set the LEARN-USE selector to LEARN.

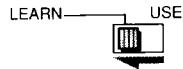

3 While keeping the LEARN CLEAR button pressed, press the button.

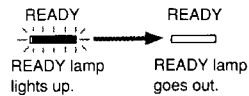

## Clearing All the Memorized Functions

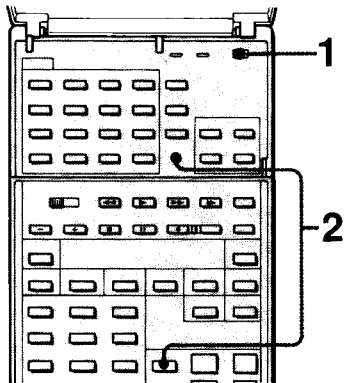

1 Set the LEARN-USE selector to LEARN.



2 While keeping the LEARN CLEAR button pressed, press the PICTURE + button.

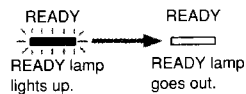

### Note

After clearing memorized functions, the buttons function for Sony video equipment again.

# Specifications

Color system NTSC system  
 Picture tube 45" Black Trinitron tube  
 Visible picture size 43-inch measured diagonally  
 110-degree deflection  
 Resolution Horizontal 560 TV lines  
 Vertical 450 TV lines

## Inputs

### VIDEO 1S, 2S, 3S IN

Y/C input, 4-pin DIN  
 Y: 1 Vp-p, sync negative, 75-ohm termination switchable  
 C: 0.286 Vp-p, (burst signal), 75-ohm termination switchable  
 Pin assignment

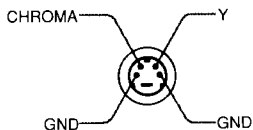

### VIDEO 1, 2, 3 IN

Composite video input, BNC  
 1 Vp-p, sync negative, 75-ohm termination switchable  
 The Y/C input has priority over the composite video input.

### RGB (15.75 kHz)

BNC  
 R, G, B: 0.7 Vp-p, positive, 75-ohm terminated  
 Composite sync: 1 Vp-p, negative, 75-ohm terminated  
 H/V separate sync: TTL, negative/positive  
 Sync on Green: 0.3 Vp-p, negative, 75-ohm terminated  
 Acceptable frequency: 15.75 kHz horizontally, 60 Hz vertically

### RGB (31.5 kHz)

BNC  
 R, G, B: 0.7 Vp-p, positive, 75-ohm terminated  
 Composite sync: 1 Vp-p, negative, 75-ohm terminated  
 H/V separate sync: TTL, negative/positive  
 Sync on Green: 0.3 Vp-p, negative, 75-ohm terminated  
 Acceptable frequency: 31.5 kHz horizontally, 60 Hz vertically

Audio Phono jack, 500 mVrms, input impedance more than 47 kohms  
 CONTROL S 1 line, minijack, 5 Vp-p

## Outputs

### VIDEO 1S, 2S, 3S OUT

Y/C output, 4-pin DIN, loop-through

### VIDEO 1, 2, 3 OUT

Composite video output, BNC, loop-through

Audio Phono jack, loop-through

CONTROL S 1 line, minijack, 5 Vp-p

SPEAKER OUT 8 ohms (7W + 7W), impedance 8-16 ohms

Power requirements 120 V AC, 50/60 Hz

Power consumption Max. 400 W

Operating temperature

0°C to 35°C (32°F to 95°F)

Dimensions Approx. 1,050 × 925 × 767 mm (w/h/d)  
 (41<sup>3</sup>/<sub>8</sub> × 36<sup>1</sup>/<sub>2</sub> × 30<sup>1</sup>/<sub>4</sub> inches)

Weight Approx. 200 kg (440 lb 15 oz)

Supplied accessories

Remote commander RM-778 with 4 size AA batteries (1)  
 AC power cord (1)  
 BNC-phono adaptor plug (4)

Optional accessories

APM-X5A speaker system

Design and specifications subject to change without notice.